



禾剛企業有限公司  
HOU GUN ENTERPRISE CO., LTD.

REV	DESCRIPTION	DATE
A		220111

客戶簽名確認章

TITLE  
M12 MALE MOLDING CABLE

P/N:

DWG. NO: HGMxx-M12xxP-CB

DR. Dan		UNIT: mm
---------	--	----------

CH. Jason	SCALE	1:1
-----------	-------	-----

AP. Lanny	UNLESS OTHERWISE SPECIFIED TOLERANCES:
-----------	--

REV. A	SHEET 1/1	x ± 0.20 xxx ± 0.05 xx ± 0.10 ANGLE ± 1°
--------	-----------	---

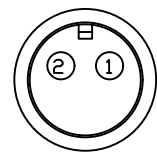

HGM15-M1202P-CB

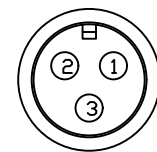

HGM15-M1203P-CB

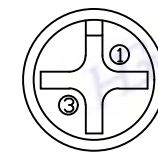

HGM04-M1202P-CBR

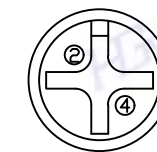

HGM04-M1202P-CBL

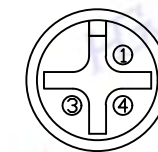

HGM04-M1203P-CBR

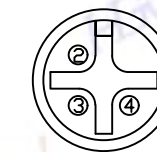

HGM04-M1203P-CBL

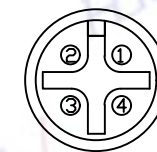

HGM04-M1204P-CB

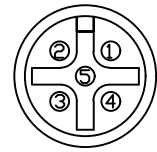

HGM04-M1205P-CB

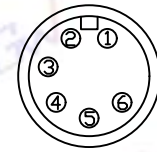

HGM02-M1206P-CB



HGM02-M1207P-CB



HGM02-M1208P-CB



HGM02-M1210P-CB



HGM01.5-M1212P-CB

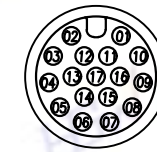

HGM01.5-M1217P-CB

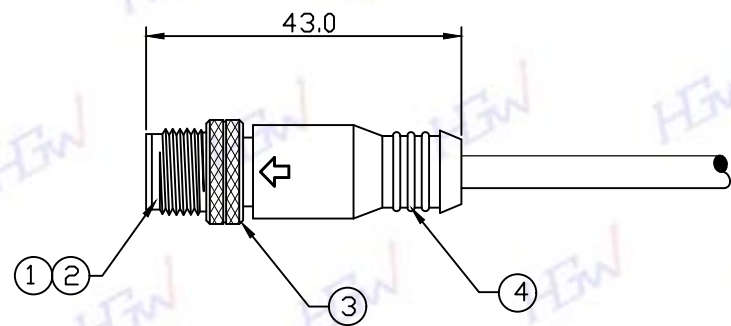

NOTES:

1.ELECTRICAL SPECIFICATION

- 1-1.RATED CURRENT: 15A/4A/2A/1.5A
- 1-2.RATED VOLTAGE: 250V/60V/30V
- 1-3.WATERPROOF: IP67

2.ENVIRONMENTAL

- 2-1.OPERATION TEMPERATURE: -20°~80°C

3.PART NUMBER SPECIFICATION

- 3-1.HGMxx-M12xxP-CB

- 02 - 2 PINS 07 - 07 PINS
- 03 - 3 PINS 08 - 08 PINS
- 04 - 4 PINS 10 - 10 PINS
- 05 - 5 PINS 12 - 12 PINS
- 06 - 6 PINS 17 - 17 PINS

- 1.CONNECTOR: M12 MALE CONNECTOR INSERT ,for1
- 2.CONTACT: BRASS,MALE PIN,GOLD FLASH ,forN
- 3.RING NUT: BRASS,NICKEL PLATED ,for1
- 4.MOLDING: PVC ,for1

- 15-CURRENT RATING 15A
- 04-CURRENT RATING 4A
- 02-CURRENT RATING 2A
- 01.5-CURRENT RATING 1.5A

RATED VOLTAGE: 2~4PIN/250V ; 5~10PIN/60V ; 12,17PIN/30V