



禾剛企業有限公司  
HOU GUN ENTERPRISE CO., LTD.

REV	DESCRIPTION	DATE
A		220111

客戶簽名確認章

TITLE  
M8 FEMALE MOLDING CABLE

P/N:

DWG. NO: HGFxx-M8xxP-CB

DR. Dan		UNIT: mm
---------	--	----------

CH. Jason	SCALE	2:1
-----------	-------	-----

AP. Lanny	UNLESS OTHERWISE SPECIFIED TOLERANCES:	
-----------	--	--

REV. A	SHEET 1/1	X ± 0.20 XX ± 0.10	XXX ± 0.05 ANGLE ± 1°
--------	-----------	-----------------------	--------------------------

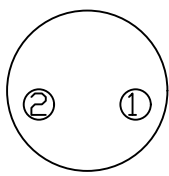

HGF04-M802P-CB

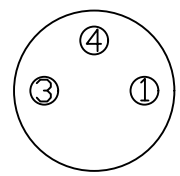

HGF04-M803P-CB

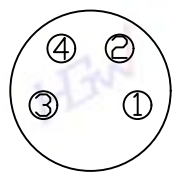

HGF04-M804P-CB

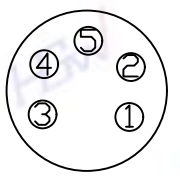

HGF02-M805'P-CB



HGF02-M806'P-CB

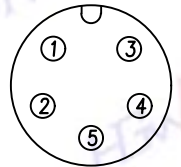

HGF02-M805P-CB



HGF02-M806P-CB

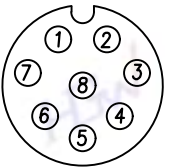

HGF01.5-M808P-CB

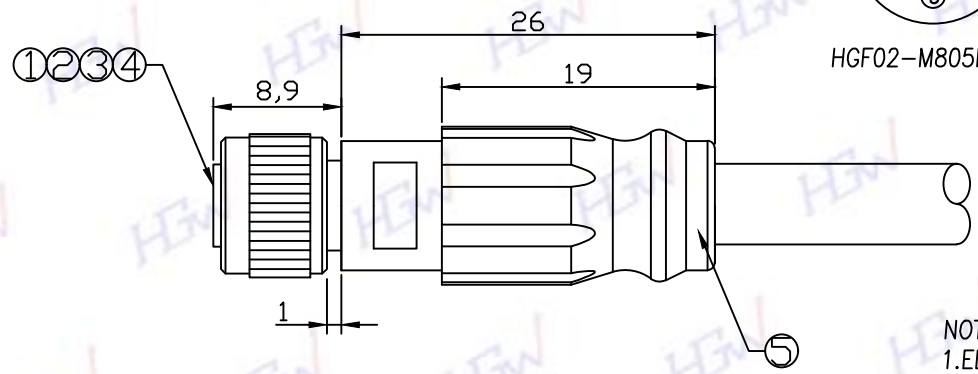

NUT for 2,3,4 PIN

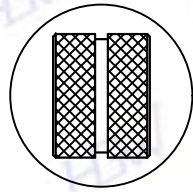

NUT for 5,6' PIN

NOTES:

1.ELECTRICAL SPECIFICATION

- 1-1.RATED CURRENT: 4A/2A/1.5A
- 1-2.RATED VOLTAGE: 60V/30V
- 1-3.WATERPROOF: IP67

2.ENVIRONMENTAL

- 2-1.OPERATION TEMPERATURE: -20~80°C

3.PART NUMBER SPECIFICATION

- 3-1.HGMxx-M8xxP-CB

- 02 - 2 PINS    03 - 3 PINS
- 04 - 4 PINS    05 - 5 PINS
- 06 - 6 PINS    08 - 8 PINS

- 04-CURRENT RATING 4A
- 02-CURRENT RATING 2A
- 01.5-CURRENT RATING 1.5A

- 1.CONNECTOR: M8 FEMALE CONNECTOR ,for1
- 2.CONTACT: BRASS,FEMALE PIN,NICKEL PLATED ,forN
- 3.O-RING: VITON ,for1
- 4.RING NUT: BRASS,NICKEL PLATED (WITH RATCHET MECHANISM, WITHOUT SLEEVE) ,for1
- 5.MOLDING: PVC ,for1