

HGF05-M1603P-CB

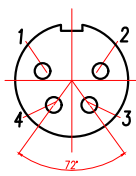

HGF05-M1604P-CB

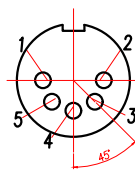

HGF05-M1605P-CB

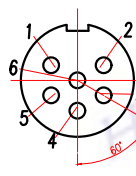

HGF05-M1606P-CB



HGF05-M1607P-CB

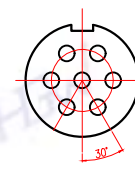

HGF05-M1607P-CB

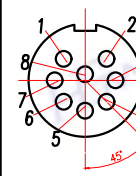

HGF05-M1608P-CB

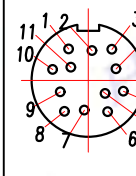

HGF03-M1612P-CB

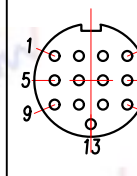

HGF03-M1613P-CB

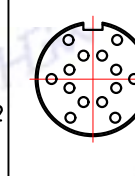

HGF03-M1614P-CB



禾剛企業有限公司
HOU GUN ENTERPRISE CO., LTD.

REV	DESCRIPTION	DATE
A		220106

客戶圖面確認簽回章

TITLE M16 FEMALE & MOLDED
CABLE ASSY

P/N:	
DWG. NO: HGFxx-M16xxP-CB	
DR. Dan	UNIT: mm
CH. Jason	SCALE 1:1
AP. Lanny	UNLESS OTHERWISE SPECIFIED TOLERANCES:
REV. A	SHEET 1/1
	x ± 0.20 xxx ± 0.05 xx ± 0.10 ANGLE ± 1°

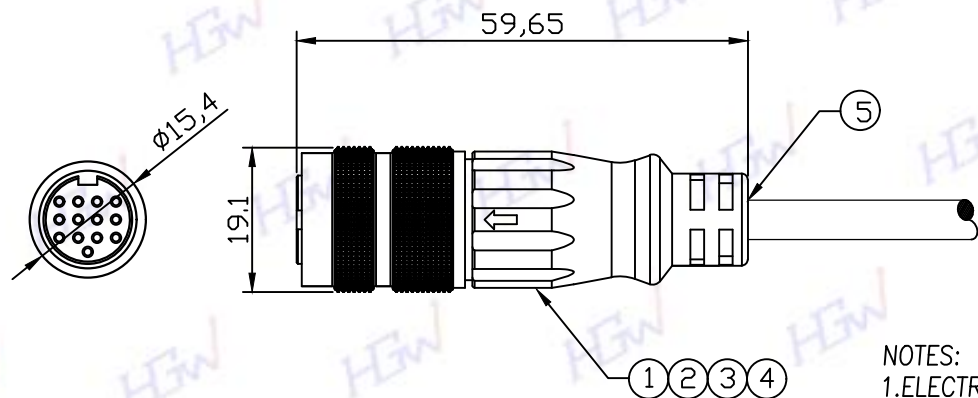

- NOTES:
- ELECTRICAL SPECIFICATION
 - 1-1. RATED CURRENT: 5A/3A
 - 1-2. RATED VOLTAGE: 250V/60V
 - 1-3. WATERPROOF: IP67
 - ENVIRONMENTAL
 - 2-1. OPERATION TEMPERATURE: -40°~85°C
 - PART NUMBER SPECIFICATION
 - 3-1. HGMxx-M16xxP-CB
 - 03 - 3 PINS 04 - 4 PINS
 - 05 - 5 PINS 06 - 6 PINS
 - 07 - 7 PINS 08 - 8 PINS
 - 12 - 12 PINS 13 - 13 PINS
 - 14 - 14 PINS

- NOTE:
- CONNECTOR: M16 DIN Female Connector ,for1
 - CONTACT: Brass,Female Pin,Gold Flash ,forN
 - RING-NUT: Brass,Nickel Plated,BLACK ,for1
 - O-RING: EPDM
 - MOLDING: PVC ,for1

05-CURRENT RATING 5A
03-CURRENT RATING 3A