

HGM20-CS03P-CB

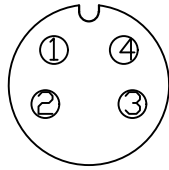

HGM10-CS04P-CB

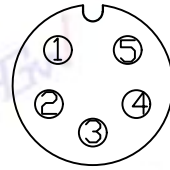

HGM10-CS05P-CB

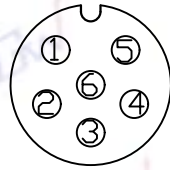

HGM10-CS06P-CB

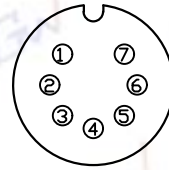

HGM05-CS07P-CB

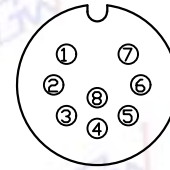

HGM05-CS07P-CB

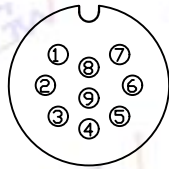

HGM05-CS09P-CB

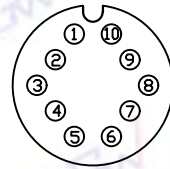

HGM02-CS10P-CB

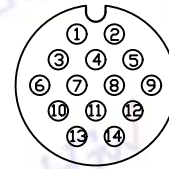

HGM02-CS14P-CB

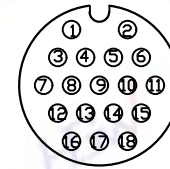

HGM02-CS18P-CB

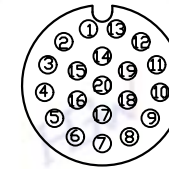

HGM02-CS20P-CB



禾剛企業有限公司
HOU GUN ENTERPRISE CO., LTD.

REV	DESCRIPTION	DATE
A		220106

客戶簽名確認章

TITLE
CIRCULAR C SIZE LOCK TYPE
MALE CABLE

P/N:

DWG. NO: HGMxx-CSxxP-CB

DR. Dan UNIT: mm

CH. Jason SCALE 1:1

AP. Lanny UNLESS OTHERWISE SPECIFIED TOLERANCES:

REV.	SHEET	TOLERANCES
A	1/1	x ± 0.20 xxx ± 0.05 xx ± 0.10 ANGLE ± 1°

NOTES:

1.ELECTRICAL SPECIFICATION

1-1.RATED CURRENT: 20A/10A/5A/2A

1-2.RATED VOLTAGE: 250V

1-3.WATERPROOF: IP67

2.ENVIRONMENTAL

2-1.OPERATION TEMPERATURE: -20°~80°C

3.PART NUMBER SPECIFICATION

3-1.HGMxx-CSxxP-CB

03 - 3 PINS	04 - 4 PINS
05 - 5 PINS	06 - 6 PINS
07 - 7 PINS	08 - 8 PINS
09 - 9 PINS	10 - 10 PINS
14 - 14 PINS	18 - 18 PINS
20 - 20 PINS	

20-CURRENT RATING 20A
10-CURRENT RATING 10A
05-CURRENT RATING 5A
02-CURRENT RATING 2A

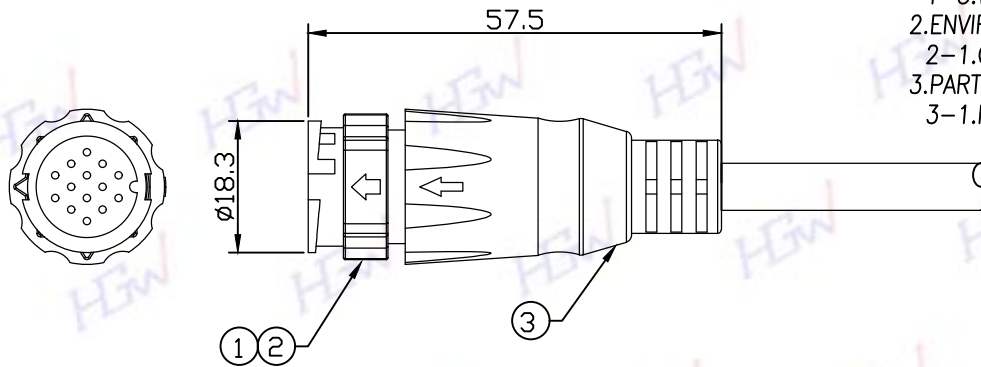

- 1.CONNECTOR: C SIZE MALE CONNECTOR ,for1
- 2.CONTACT: BRASS,MALE PIN,GOLD FLASH ,forN
- 3.MOLDING: PVC ,for1