



禾剛企業有限公司  
HOU GUN ENTERPRISE CO., LTD.

REV	DESCRIPTION	DATE
A		220425

客戶簽名確認章

TITLE  
CIRCULAR D SIZE LOCK TYPE  
FEMALE CABLE

P/N:

DWG. NO: HGFxx-DSxxP-CB

DR. Dan UNIT: mm

CH. Jason SCALE 1:1

AP. Lanny UNLESS OTHERWISE SPECIFIED TOLERANCES:

REV. A	SHEET 1/1	X ± 0.20 XXX ± 0.05 XX ± 0.10 ANGLE ± 1°
--------	-----------	---

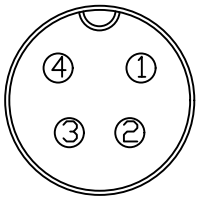

HGF20-DS04P-CB

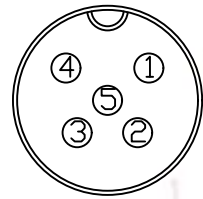

HGF20-DS05P-CB

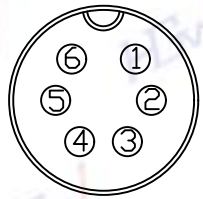

HGF20-DS06P-CB

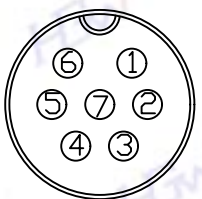

HGF20-DS07P-CB

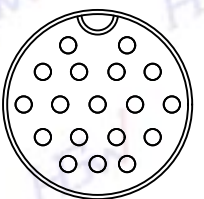

HGF05-DS18P-CB

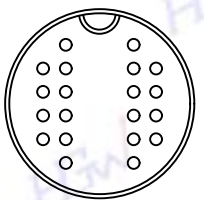

HGF02-DS20P-CB

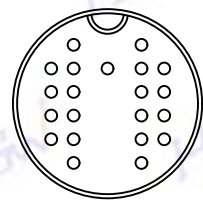

HGF02-DS21P-CB

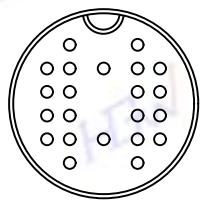

HGF02-DS22P-CB

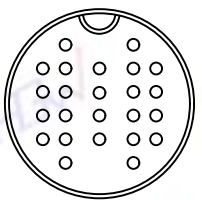

HGF02-DS24P-CB

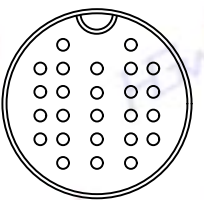

HGF02-DS25P-CB

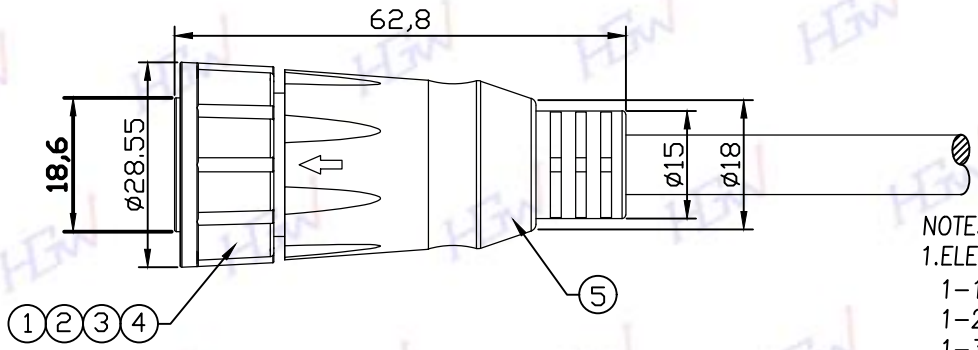

NOTES:

- 1.ELECTRICAL SPECIFICATION
  - 1-1.RATED CURRENT: 20A/5A/2A
  - 1-2.RATED VOLTAGE: 300V
  - 1-3.WATERPROOF: IP67
- 2.ENVIRONMENTAL
  - 2-1.OPERATION TEMPERATURE: -20°~80°C
- 3.PART NUMBER SPECIFICATION
  - 3-1.HGFxx-DSxxP-CB

- 1.CONNECTOR: D SIZE FEMALE CONNECTOR ,for1
- 2.CONTACT: BRASS,FEMALE PIN,GOLD FLASH ,forN
- 3.LOCK NUT: PA66 ,for1
- 4.O-RING: SILICON ,for1
- 5.MOLDING: PVC ,for1

04 - 4 PINS	05 - 5 PINS
06 - 6 PINS	07 - 7 PINS
18 - 18 PINS	20 - 20 PINS
21 - 21 PINS	22 - 22 PINS
24 - 24 PINS	25 - 25 PINS
20-CURRENT RATING 20A	
05-CURRENT RATING 5A	
02-CURRENT RATING 2A	