

HGF15-M1202P-CB90

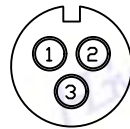

HGF15-M1203P-CB90



HGF04-M1202P-CB90

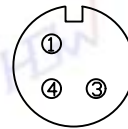

HGF04-M1203P-CB90

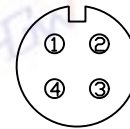

HGF04-M1204P-CB90



HGF04-M1205P-CB90

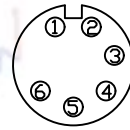

HGF02-M1206P-CB90

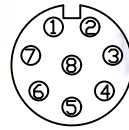

HGF02-M1208P-CB90

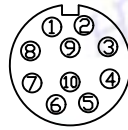

HGF02-M1210P-CB90



HGF01.5-M1212P-CB90

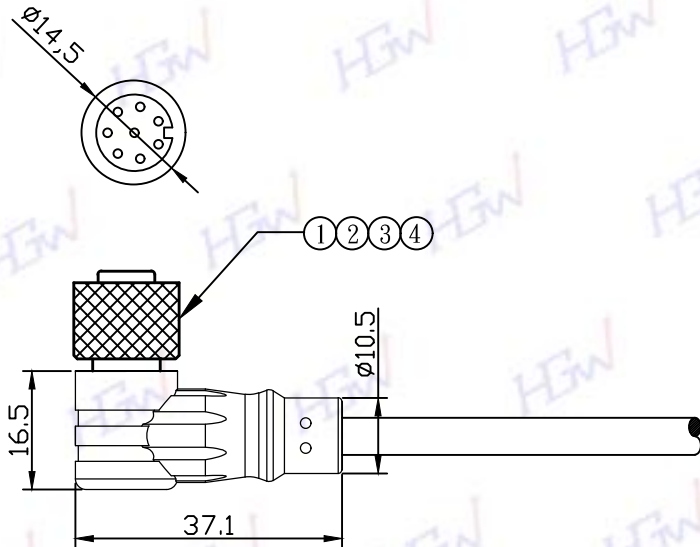

NOTE:

- 1.CONNECTOR: M12 FEMALE CONNECTOR, for1
- 2.CONTACT: FEMALE PIN, BRASS, GOLD PLATED ,for N
- 3.NUT: BRASS, NICKEL PLATED ,for1
- 4.O-RING: EPDM ,for1

NOTES:

1.ELECTRICAL SPECIFICATION

- 1-1.RATED CURRENT: 15A/4A/2A/1.5A
- 1-2.RATED VOLTAGE: 250V/60V/30V
- 1-3.WATERPROOF: IP67

2.ENVIRONMENTAL

- 2-1.OPERATION TEMPERATURE: -20~80°C

3.PART NUMBER SPECIFICATION

- 3-1.HGFxx-M12xxP-CB90

- 02 - 2 PINS 07 - 07 PINS
- 03 - 3 PINS 08 - 08 PINS
- 04 - 4 PINS 10 - 10 PINS
- 05 - 5 PINS 12 - 12 PINS
- 06 - 6 PINS 17 - 17 PINS

- 15-CURRENT RATING 15A
- 04-CURRENT RATING 4A
- 02-CURRENT RATING 2A
- 01.5-CURRENT RATING 1.5A



禾剛企業有限公司  
HOU GUN ENTERPRISE CO., LTD.

REV	DESCRIPTION	DATE
A		220106

客戶圖面確認簽回章

TITLE M12 FEMALE 90°  
MOLDING CABLE

P/N:

DWG. NO: HGFxx-M12xxP-CB90

DR. Dan		UNIT: mm
---------	--	----------

CH. Jason	SCALE	1:1
-----------	-------	-----

AP. Lanny	UNLESS OTHERWISE SPECIFIED TOLERANCES:	
-----------	--	--

REV. A	SHEET 1/1	x ± 0.20 xxx ± 0.05 xx ± 0.10 ANGLE ± 1°
--------	-----------	---